

Start Here For A Typical Installation

This guide covers typical installations. For more information on other install scenarios, please scan the QR code located on the front of the install guide.

Clean Out Your Gutters

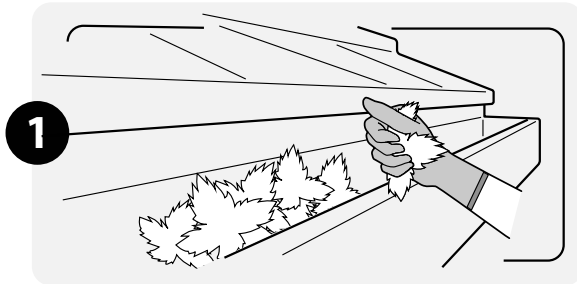

Measure & Cut Gutter Guard as Needed

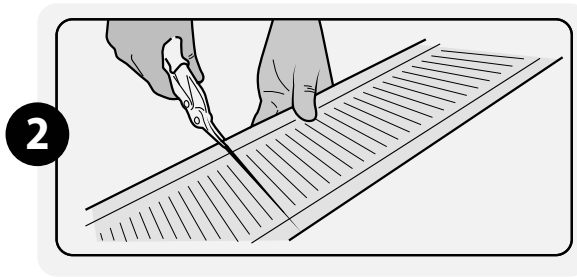

Use a new, or freshly sharpened, pair of tin snips to cut through the aluminum rail and mesh.

Determine the Slope of Your Roof

The optimum slope for gutter guard install is 5-25°.

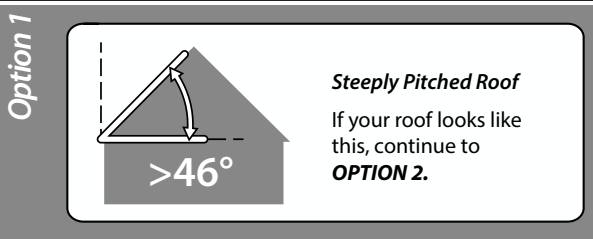
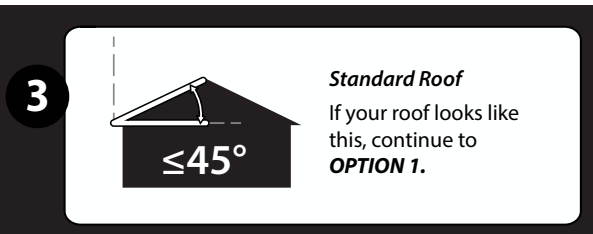

4 Start Laying First Section

We recommend starting at an inside corner. If you don't have one, start at the downspout.

Option 1 Standard Roof Installation

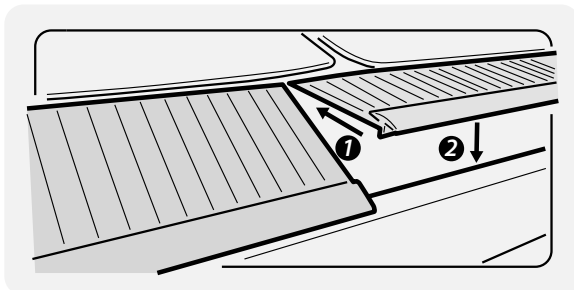

Carefully slide the rear rail of the gutter guard under the roof shingles. Continue to step 5.

IMPORTANT: If your roofing material is adhered to your underlayment, do not use this method. Use the bending method demonstrated in Option 2.

OR

CONTINUE TO OPTION 2 →

Option 2 Below the Roofline Installation

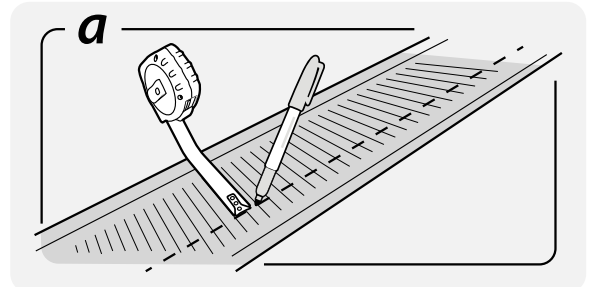

MEASURE & MARK: Measure the length from the lip of the gutter to the fascia board. Using that measurement, mark a line on the gutter guard where you will bend the mesh.

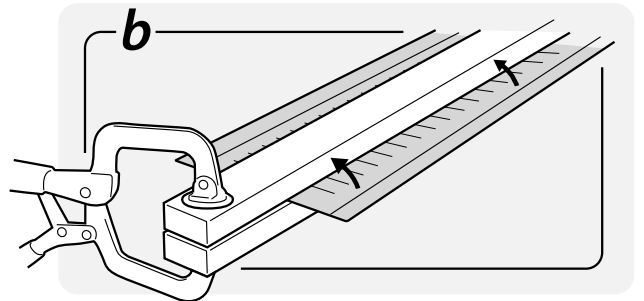

CLAMP MESH: Clamp the gutter guard between two 1"x2" boards to hold it in place.

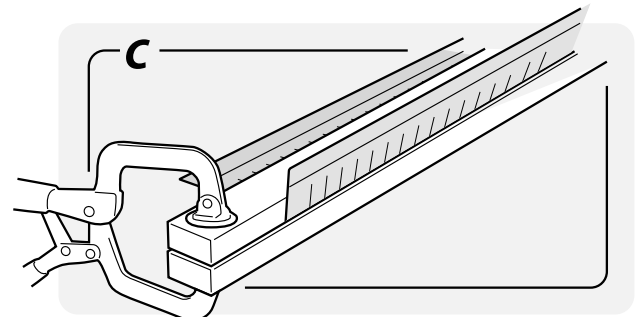

BEND THE MESH: Use the leverage from the clamp and/or boards to bend the mesh along the line you've marked. Note: Bend the mesh either up or down depending on your gutter-to-roof scenario.

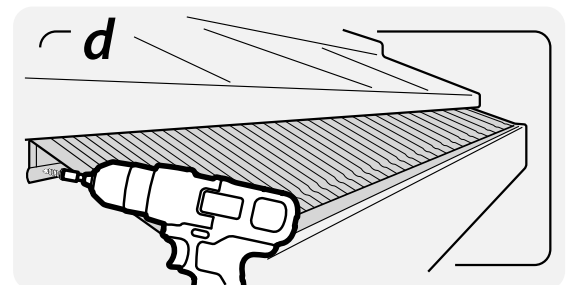

INSTALL GUARDS: Screw the mesh to the fascia board using 3 screws per section. Continue to step 5.

5 Use Screws To Attach

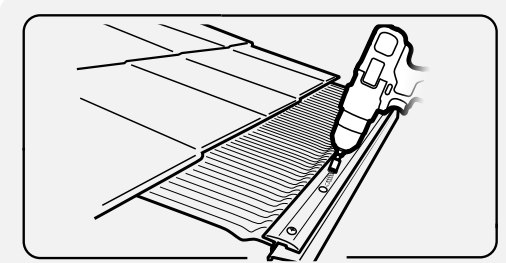

SCREW IT DOWN: Use the guides on the front rail to place the screw. Fasten with 3 screws for each section.



DO NOT RETURN THIS PRODUCT TO THE STORE!

Please contact our Customer Experience Team at (844) 359-7691. We likely will be able to resolve the issue.

Safety Is Our #1 Priority.

During installation we recommend that you...

- Wear gloves and safety glasses.
- Use an extension ladder and standoff for stability.
- Make all cuts and bends to the gutter guards on the ground.

ALSO MAKE SURE TO:

- Obey local building codes.
- Check to see if your roofing material is adhered to your underlayment. Do not pry up your shingles or tear your underlayment. Find alternate methods by scanning the QR code on the front cover.
- Remove any labels/stickers from the gutter guard piece as needed.

FREEZING CONDITIONS

If you live in an area that is prone to freezing, the following issues can occur with any gutter guard:

Icicles & Ice Dams

Icicles and ice dams may form on your gutter during freezing conditions. Ice dams can cause water to leak back into your home. Icicles can break and cause serious bodily harm and injury. Properly installed, operated and maintained heating elements on your roof and gutter can melt icicles and ice dams. Use a local licensed electrical contractor in good standing for installing any heating element products.

Snow Melting

Snow melt may result in water runoff from your roof which can refreeze on the ground below creating a potential slipping hazard.

HOW-TO Inside Corners

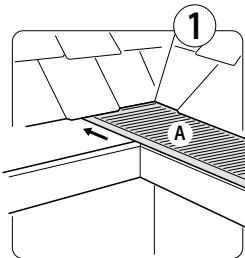

Slide piece A into the inside corner of your gutter.

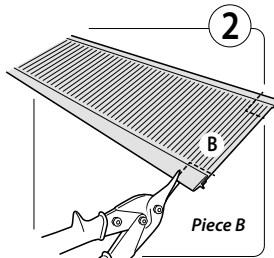

For piece B, trim back the aluminum rail about 1"; leaving some mesh exposed.

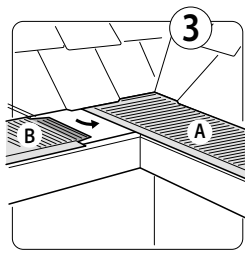

Tuck the exposed mesh of piece B down inside the gutter adjacent to the adjoining gutter guard.

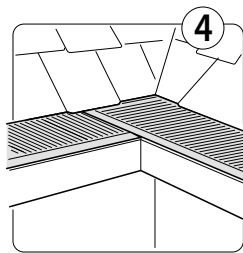

This is a completed inside corner. For heavy rain flow areas, you may need to add rain diverters.

HOW-TO Outside Corners

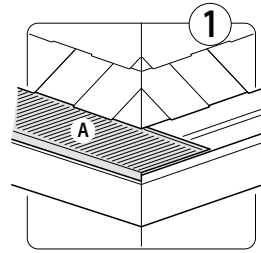

Place piece A along the outside corner.

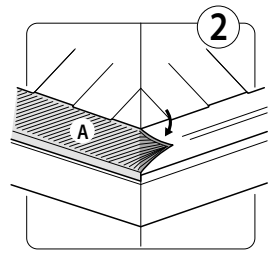

Bend down the aluminum rail and mesh to create a 45° angle.

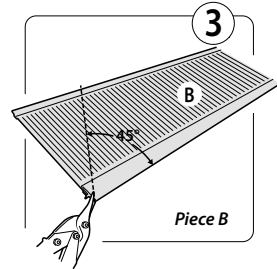

Cut piece B at a 45° angle.

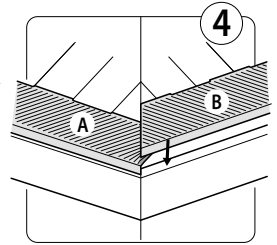

Once cut, fit it into the outside edge so that it's aligned with piece A.

HOW-TO Joining Sections

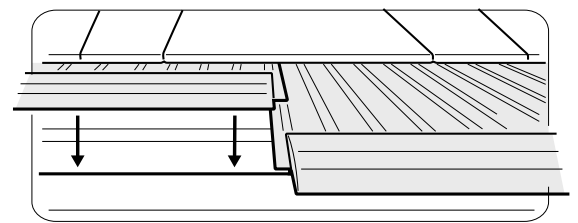

Lay one end of the mesh so it overlaps directly over the other section. Note: The rear rail has more exposed mesh than the front rail. This is intentional.

HOW-TO End Caps

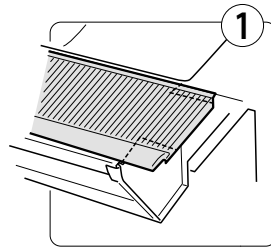

At the end of a stretch of gutter, mark on each aluminum rail where it meets the end of the gutter.

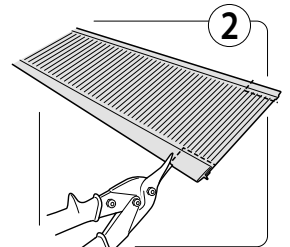

From the ground, trim back the aluminum rails where they are marked to expose the remaining mesh.

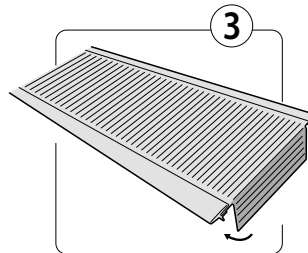

Bend and tuck the exposed mesh into the gutter. You can trim the mesh as needed to create a good covering.

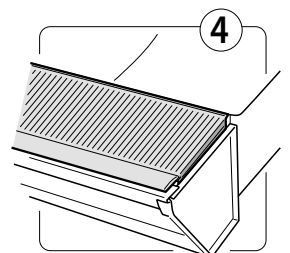

Make sure the entire gutter end is sealed to prevent debris from getting under the gutter guards.



Register Today

Register your gutter guards for our 25 year warranty!

BONUS OFFER

FREE Gift

Register your product for our 25 year warranty and get a FREE gutter guard brush.

*Shipping and handling not included.

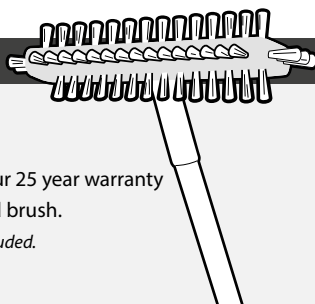

NEED HELP?

vikinggutterguards.com/contact

844.359.7691

M-F 8am-7pm CST